



Installation and troubleshooting of Cubro Optical TAPs

24 June 2017

www.cubro.com

This presentation is intended to provide installation instruction for Cubro Optical TAPs. It also helps understanding the application of TAPs and troubleshooting.

Intended target groups:

- Network planners
- Network engineers
- Field technicians

Optical TAPs



Optical Taps up to 100G	
CUB. OPTOSLIM-8-SM	optical TAP, 8 Links Singlemode; LC connectors, 19" 1/3U heigh, splitting ratio 80/20
CUB. OPTOSLIM-8-SM-5	optical TAP, 8 Links Singlemode; LC connectors, 19" 1/3U heigh, splitting ratio 50/50
CUB. OPTOSLIM-8-SM-7	optical TAP, 8 Links Singlemode; LC connectors, 19" 1/3U heigh, splitting ratio 50/50
CUB.OPTOSLIM-8-MM	optical TAP, 8 Links Multimode 50/125μ; LC connectors, 19" 1/3U heigh, splitting ratio 50/50
CUB.OPTOSLIM-8-MM6	optical TAP, 8 Links Multimode 62,5/125μ; LC connectors, 19" 1/3U heigh, splitting ratio 50/50
CBR.OPTO-1-SM	optical TAP, 1 Link SM 1310/1550nm LC, 2 Monitor Ports LC; 19" stand alone housing, splitting ratio 80%/20%
CBR.OPTO-1-SM-R3	optical TAP, 1 Link SM 1310/1550nm LC, 2 Monitor Ports LC; 1/3 19" housing, splitting ratio 80%/20%
CBR.OPTO-2-SM	optical TAP, 2 Link SM 1310/1550nm LC, 4 Monitor Ports LC; 19" stand alone housing, splitting ratio 80%/20%
CBR.OPTO-2-SM-R3	optical TAP, 2 Link SM 1310/1550nm LC, 4 Monitor Ports LC; 1/3 19" housing, splitting ratio 80%/20%
CBR.OPTO-1-MM	optical TAP, 1 Link MM 850/1300nm LC, 2 Monitor Ports LC; 19" stand alone housing, splitting ratio 50%/50%
CBR.OPTO-1-MM-R3	optical TAP, 1 Link MM 850/1300nm LC, 2 Monitor Ports LC; 1/3 19" housing, splitting ratio 50%/50%
CBR.OPTO-MTP-1	MTP TAP 40-100Gbit, Singleport, Multimode
CBR.OPTO-MTP-2	MTP TAP 40-100Gbit, Dualport, Multimode

TAPs are installed in-line.



Disconnect the LC duplex connector of SFP device B
Connect original cable to Port A of TAP

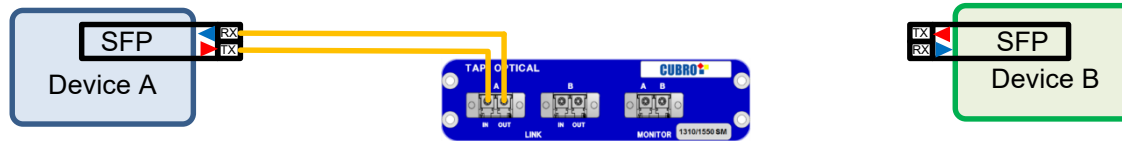

Use same type of cable to connect Port B of TAP to device B

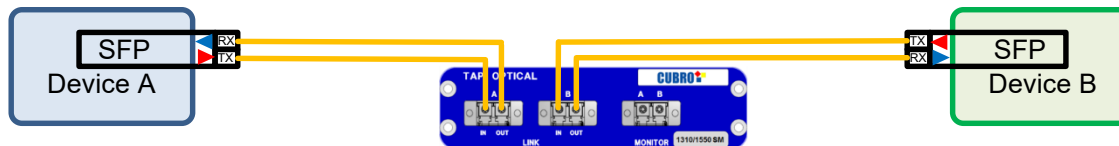

Connect monitoring equipment to Monitoring Ports A and B

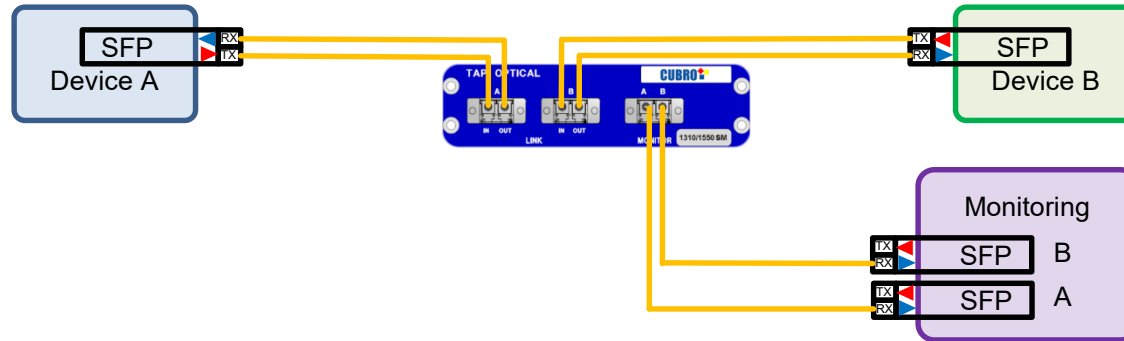

Note: There is no need to take LC duplex connectors apart, cables can stay in the original state.

- Before: SFPs are directly connected



- With TAP installed:

original cable can be reused!

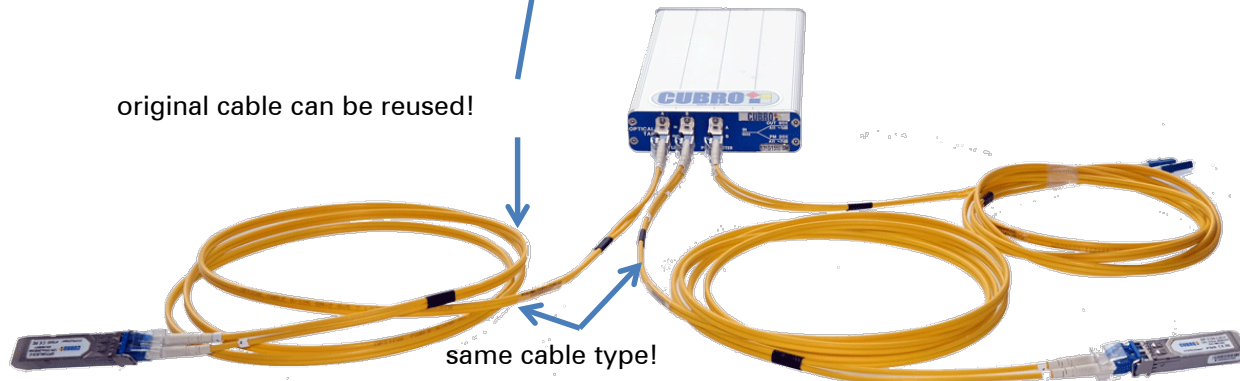

Optical 1 link TAP



1 link optical tap
Bandwidth from 100 FX to 100 Gbit,
available in

- multi mode splitting ratio 50/50
- single mode splitting ratio 80/20
- and as module for the 19" frame

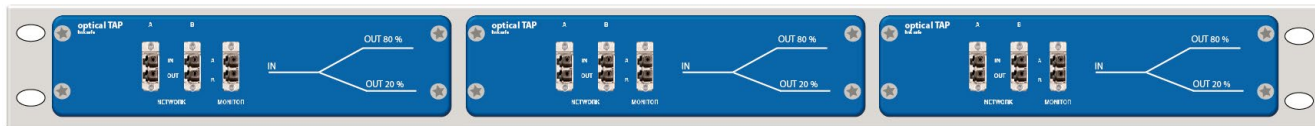

Full Signal Paths

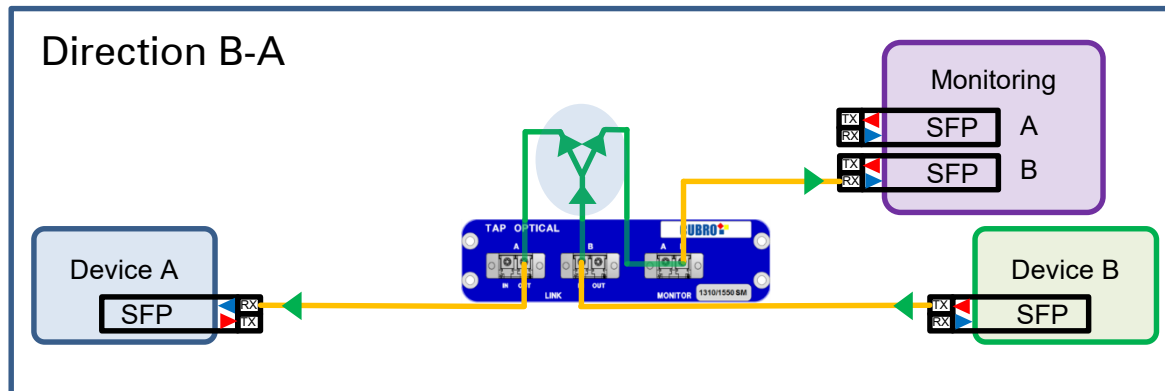
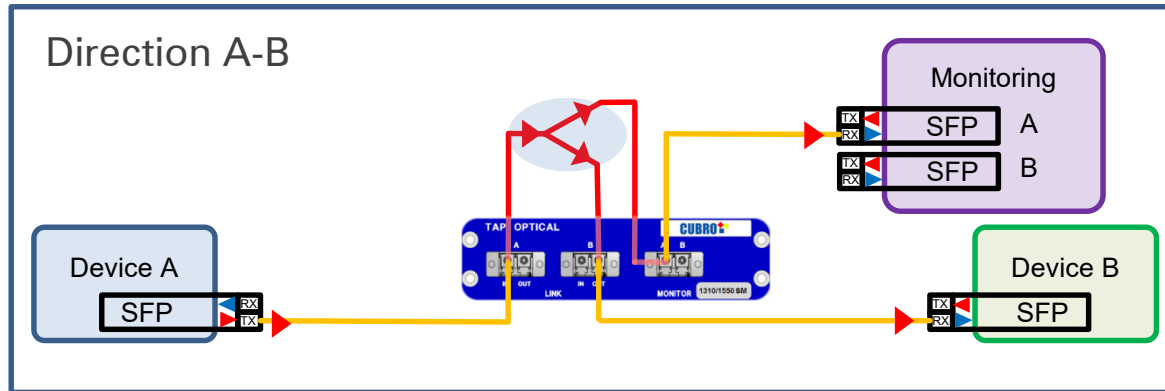

Internal Signal Paths

- Signals entering LINK IN port A are split to LINK OUT port B and MONITOR A
- Signals entering LINK IN port B are split to LINK OUT port A and MONITOR B

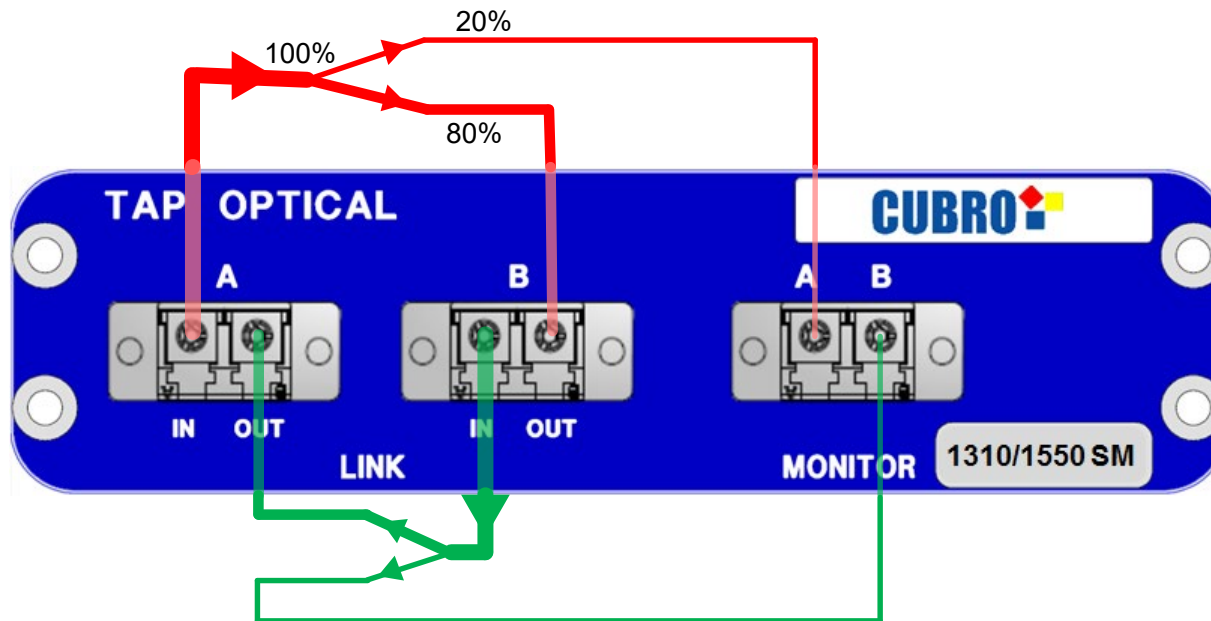

Optical Slim TAP



- 19" 1/3 U
- 8 links or 4 link version
- single mode or multi mode
- Coloured connectors for easy wiring
- Splitting ratio SM 80/20 (other ratios on request)
- Splitting ratio MM 50/50 (other ratios on request)



24 links – 1U only

Optical Slim TAP

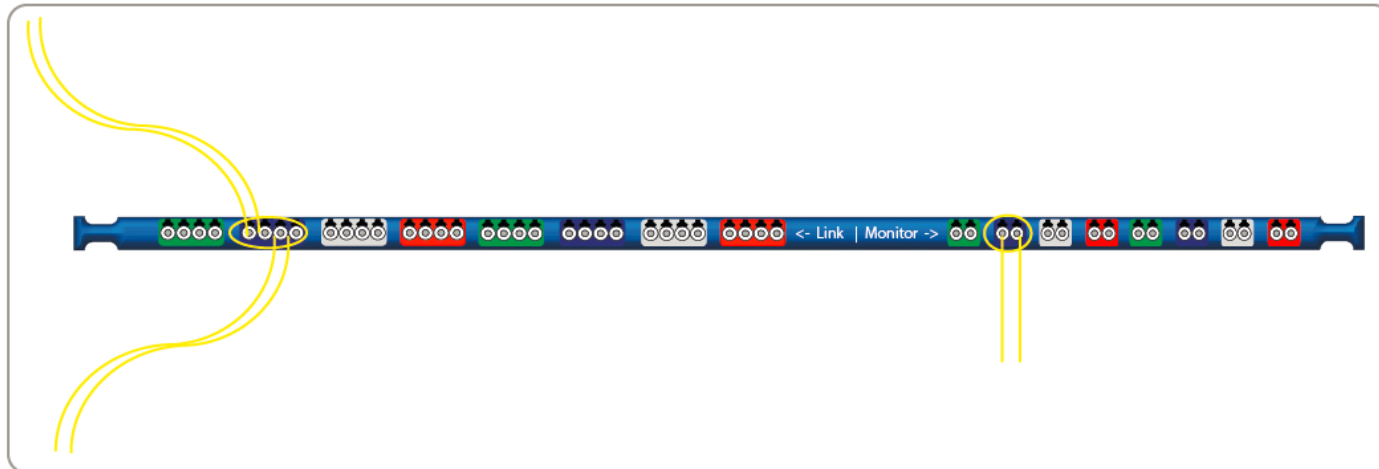
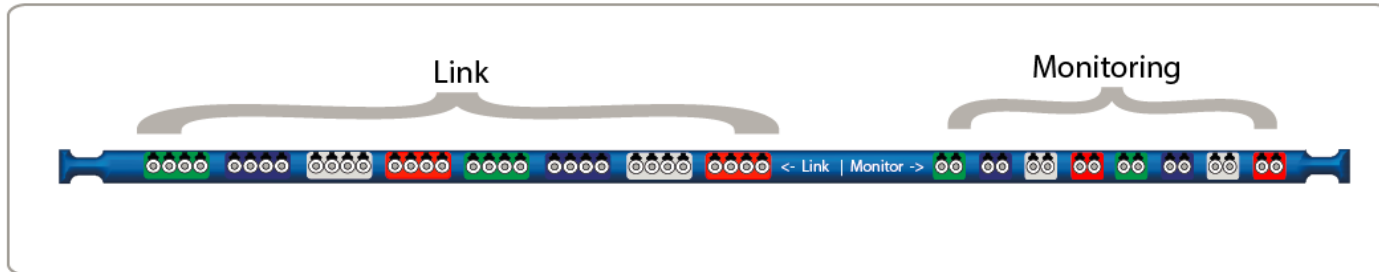

Optical power table

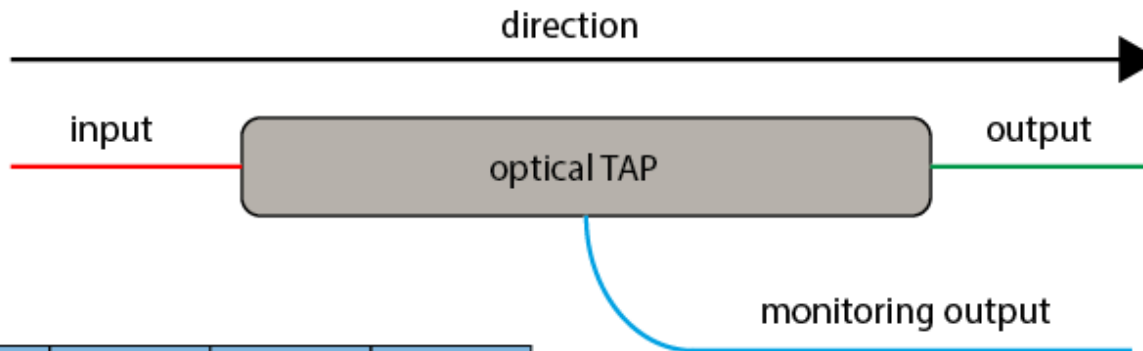

Ratio	Input	Output	Monitoring
90/10	-9 dBm	-9,46 dBm	-19,00 dBm
80/20	-9 dBm	-9,97 dBm	-15,99 dBm
70/30	-9 dBm	-10,55 dBm	-14,23 dBm
60/40	-9 dBm	-11,22 dBm	-12,99 dBm
50/50	-9 dBm	-12,01 dBm	-12,01 dBm

This two tables help to estimate an optical budget if you use an optical tap.

But consider the SFP data can varies from vendor to vendor and you also must calculate connectors and cables as a source for loosing optical power. In general it is recommended to measure with an optical power meter the real power.

! Be aware a optical tap is one directional device !

typical SFP Data	max power	min power	sensitivty
MM 850 nm SFP 1 Gbit	-3 dBm	-9 dBm	-23 dBm
SM 1310 nm SFP 1 Gbit	-3 dBm	-9 dBm	-18 dBm
MM 850 nm SFP+ 10 Gbit	-1 dBm	-6,5 dBm	-11,5 dBm
SM 1310 nm SFP+ 10 Gbit	+0,5 dBm	-8,2 dBm	-14,4 dBm
MM 850 nm QSFP 40 Gbit	+1,0 dBm	-7,6 dBm	-9,5 dBm
SM 1310 nm QSFP 40 Gbit	+2,3 dBm	-7,0 dBm	-13,4 dBm
MM 850 nm QSFP 100 Gbit	-1,0 dBm	-6,5 dBm	-8,6 dBm
SM 1310 nm QSFP 100 Gbit	+4,0 dBm	-4,3 dBm	-10,6 dBm

Internal Signal Paths Optoslim Tap



- Signals entering Link W v (in) are split to Link E λ (out) and Monitor W
- Signals entering Link E v (in) are split to Link W λ (out) and Monitor E

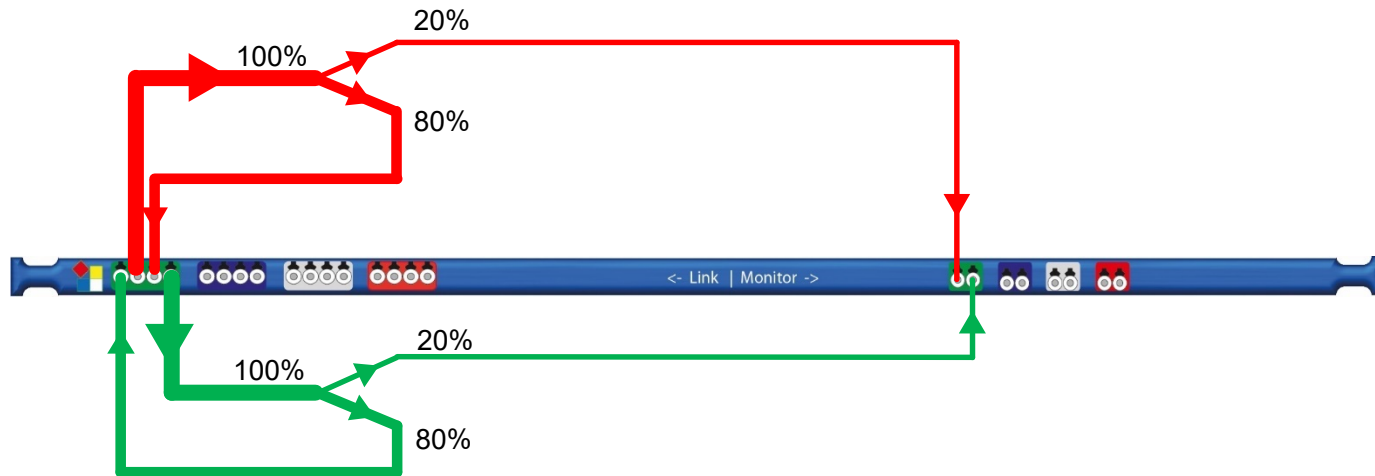

- Recommended tools:

- Visible light source with adapter/LC patch cord



- LED/Laser Source with appropriate wavelengths

- Optical Power Meter



Troubleshooting with Visual Light Source



Connect visual light source to LINK IN port A

Check if red light appears at LINK OUT Port B and associated MONITOR Port A

Repeat for side B to check both directions

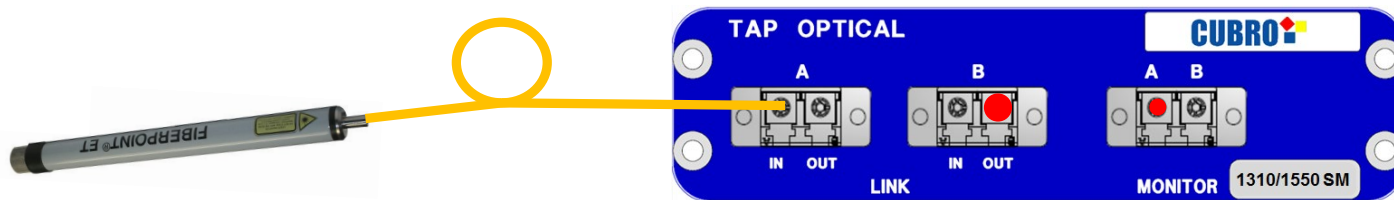

Note: Red light (usually 635 nm or 650 nm) is NOT split in the specified splitting ratio because it is out of the operating window of the splitters! Thus e.g. a 50/50 Multimode TAP might have significant differences in the intensity of the red light at the outputs.

Troubleshooting with Loss Test Set



- Connect LED or laser source to LINK IN port A
- Connect optical power meter to LINK OUT port B → measure
- Connect optical power meter to MONITOR port A → measure
- Repeat for side B to check both directions

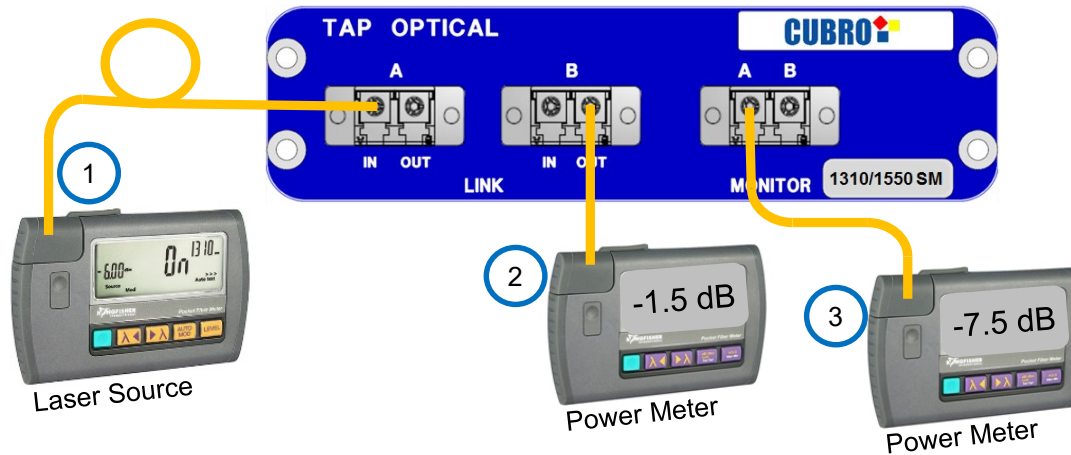

Typical attenuation values including connector loss:

TAP Ratio	Attenuation	
	Output	Monitor
90/10	1 dB	10.5 dB
80/20	1.5 dB	7.5 dB
70/30	2 dB	5.7 dB
60/40	2.7 dB	4.5 dB
50/50	3.5 dB	3.5 dB

Note: Excess attenuation usually results from dirty or damaged connectors of TAP or patchcord. Clean both connector sides and check with Fiber Inspection Microscope to optimize attenuation.

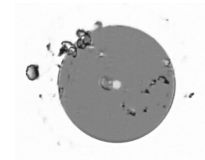

Optical BiDi TAP

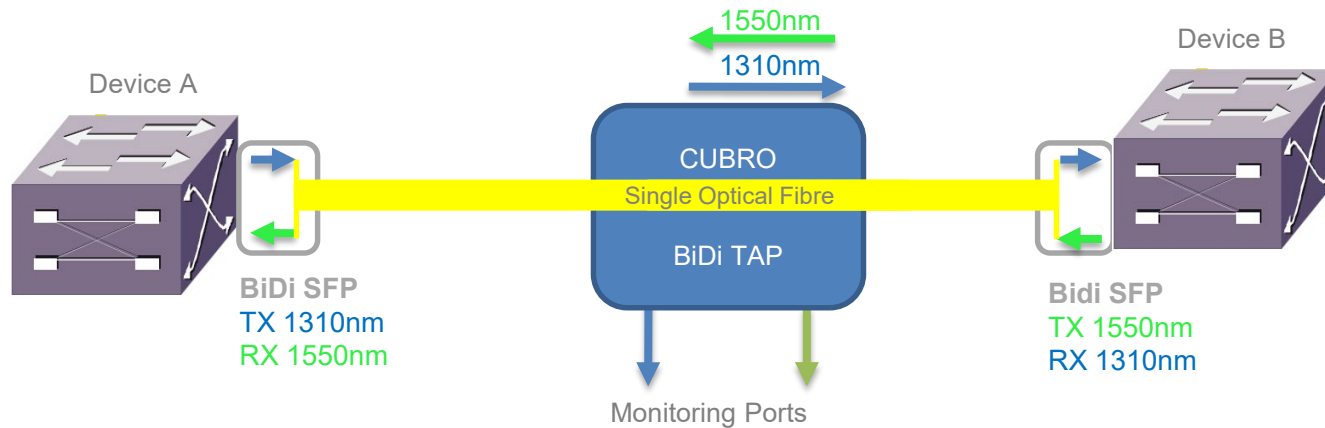

- Fully passive and secure
- Supports 1310/1550nm, 1310/1490nm and also 1490/1550nm
- 19" frame/holder for 3 units available
- Monitoring Ports can be further aggregated



BiDi TAP Application

- Fully transparent
- Fully passive

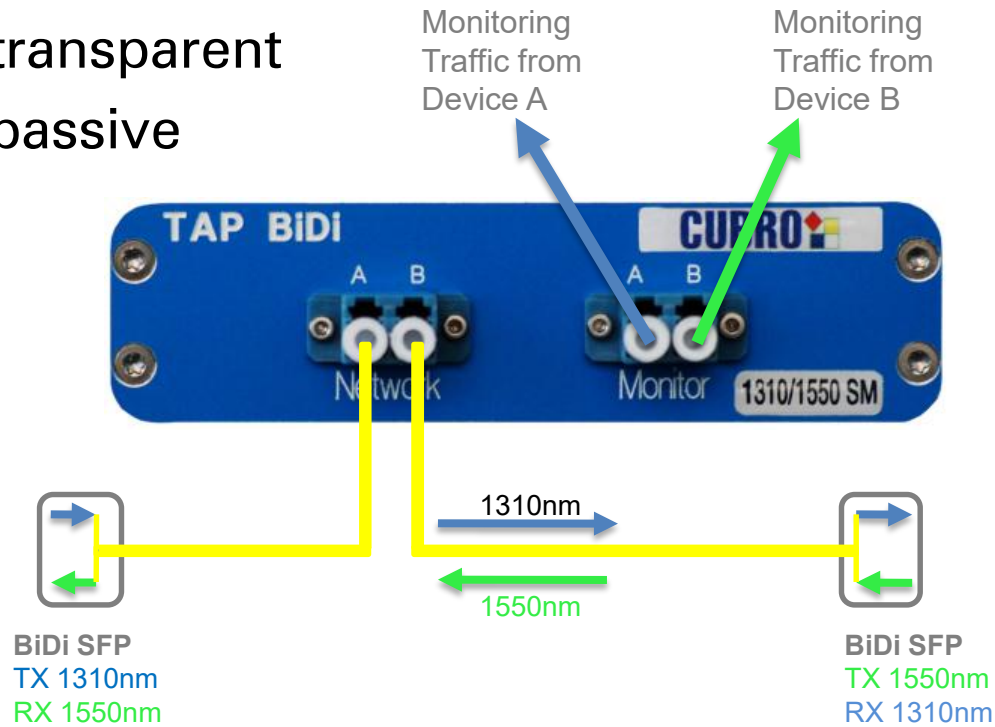

- Fully transparent
- Fully passive

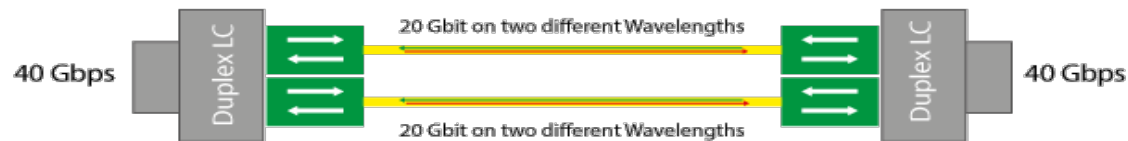
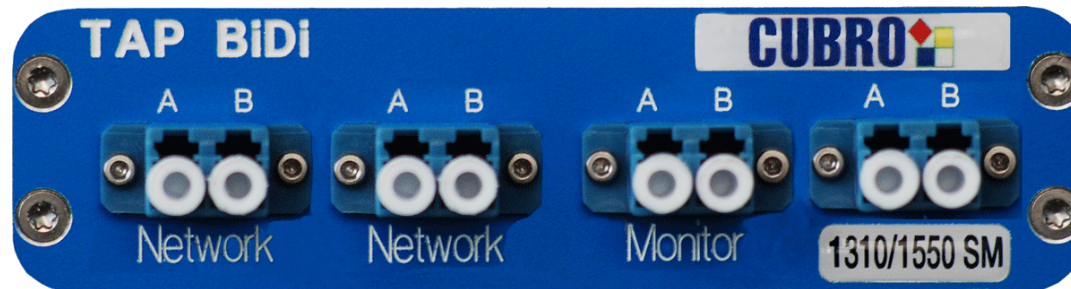

- Fully transparent
- Fully passive

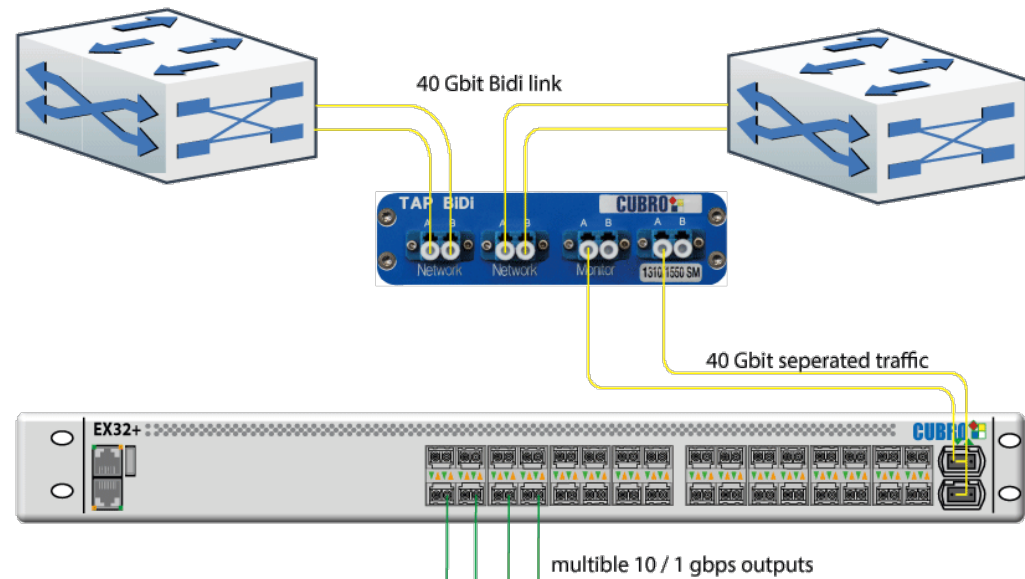

Optical MTP TAP



This device is designed to split 40 and 100 Gbit links with QSFP and QSFP28 optical modules (4 fiber pairs) available in single- and multimode.

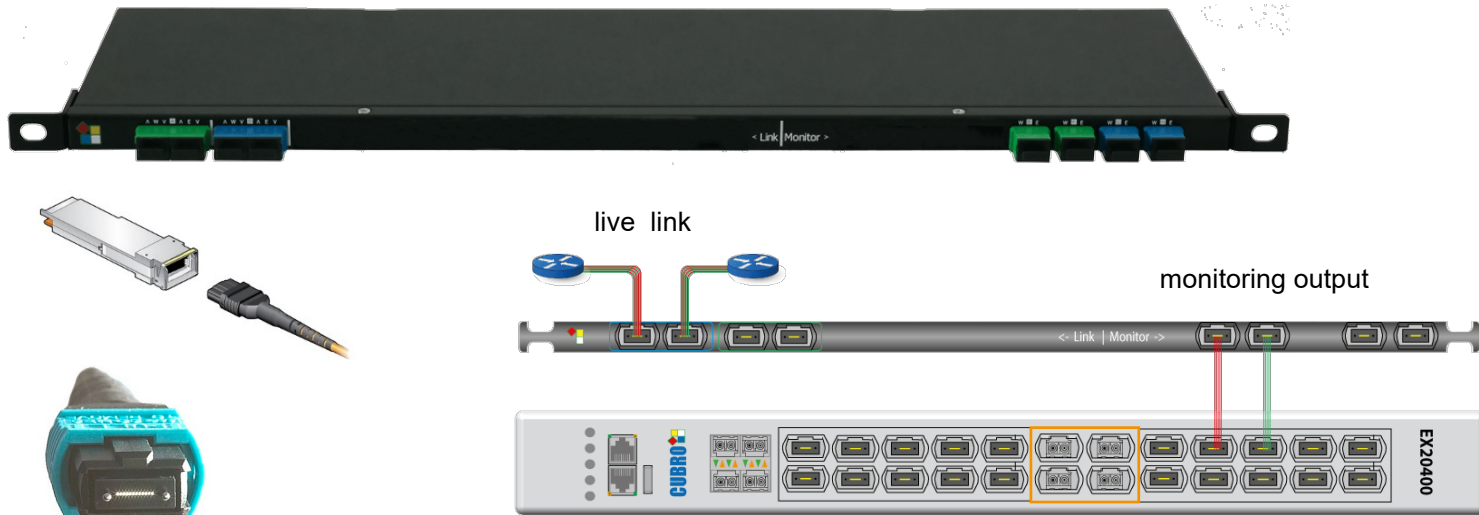

MTP Connector

100 Gbit multi mode (SR) solution



A 100 Gig link multi-mode 850 nm is typically realized with 4 fibre pairs, each of them is transporting 25 Gbit/sec. The connector of the QSFP28 or CFP2 is a MTP/MTO connector with 8 fibres.

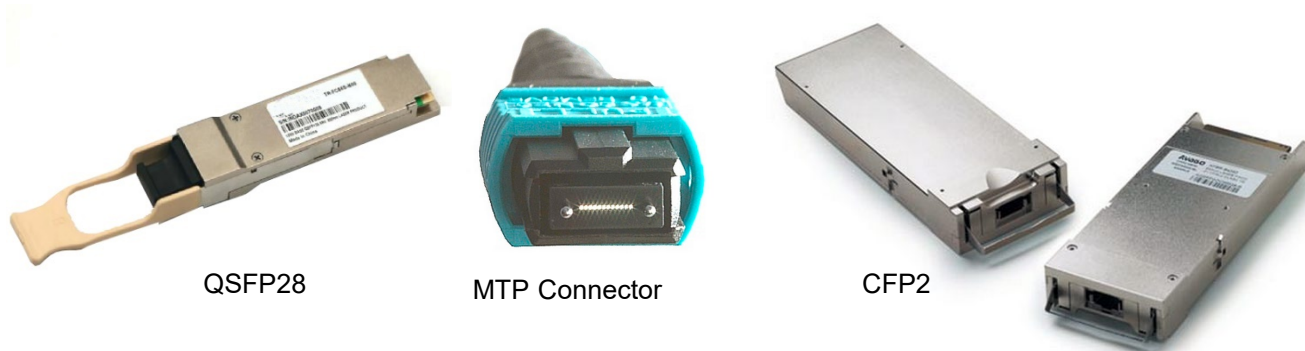

QSFP28

MTP Connector

CFP2

Thank you



Support / Additional Questions

EMEA



North America



APAC



hkaco.com



关注我们

需要详细信息? 请通过sales@hkaco.com联系我们 | 电话: 400-999-3848

办事处: 广州 | 北京 | 上海 | 深圳 | 西安 | 武汉 | 成都 | 沈阳 | 香港 | 台湾 | 美国